

E Series

Fully-Automatic Coffee Machine

Model E60/E60L



Content

1 For your safety	01
1.1 Proper use	01
1.2 Prerequisites for using the coffee machine	01
1.3 Explanation of safety symbols	02
1.4 General safety concerns when using the coffee machine	02
2 Description of machine	05
2.1 Machine overview	05
2.2 Screen interface	07
2.3 Scope of delivery	08
2.4 Technical data	09
3 Installation	09
3.1 Installation tips	09
3.2 Dimensions	10
3.3 Installation location	11
3.4 Electrical connection	11
3.5 Water supply connection	12
4 Start-up for the first time	13
4.1 Material filling	13
4.2 Initially start-up program setting	13
5 Operation	14
5.1 Coffee beans filling	14
5.2 Water tank filling	15
5.3 Milk connection	15
5.4 Switch on the machine	16
5.5 Beverage preparation	16
5.6 Grinding coarseness setting	17
6 Program setting	17
6.1 Access to the menu	17

Content

6.2 Program setting menu tree	18
6.3 Short cut function	19
6.4 Machine setting	20
6.5 Maintenance	25
6.6 Statistics	26
6.7 Advertising setting	26
6.8 Security&privacy	27
6.9 Individualization	27
6.10 About equipment	29

7 Cleaning and maintenance 30

7.1 Cleaning intervals overview	30
7.2 Parts preparation	30
7.3 Daily cleaning	31
7.4 Weekly cleaning	34
7.5 Clean the brew unit if presents	37
7.6 Descaling if presents	38

8 Messages and explanation 39

8.1 Operational messages	39
8.2 Error message	40

9 Decommissioning 41

9.1 Prepare for decommissioning	41
9.2 Short-term decommissioning (within one month)	41
9.3 Long-term decommissioning (over one month)	42

10 Transport and storage 42

10.1 Transport	42
10.2 Storage	42
10.3 Recommissioning after prolonged periods of storage or non-use	43

11 Disposal 43

1. For your safety

1.1 Proper use

1.1.1 Coffee machine

1. The E60 series are commercial machines for preparing drinks and are intended for use in food services, offices, hotel, convenience store and other similar environments.
2. The E60 series are designed to process coffee beans and fresh milk.
3. The E60 series are intended for operation indoors but are not suitable for use outdoors.

1.2 Prerequisites for using the coffee machine

1. The E60 series are intended for use only by trained personnel.
2. Do not operate the E60 series or add-on units until you have completely read and understood relative description.
3. Self-service coffee machines must always be monitored to protect the users.
4. Do not use the E60 series or add-on units if you are not familiar with the various functions.
5. Do not use the E60 series unless the machine or the add-on units have been cleaned or filled as intended.
6. Children under the age of 8 are not permitted to use the E60 series and the add-on units. After learning safe ways to use the machine and understanding the risks result from incorrect ways. Children over the age of 8 and persons with reduced physical, sensory, or mental capabilities or with inexperienced or lack knowledge in how to use the machine are permitted to use the E60 series under the continuous supervision.

1.3 Explanation of safety symbols

Observation of these safety instructions is imperative to ensure personal safety and the intactness of machine. Symbols and signal words indicate the level of hazards as follows:



WARNING

WARNING indicates a potential danger, if not avoided, will may result in death or moderate injury.



CAUTION

CAUTION indicates a hazardous situation which, if not avoided, could result in minor or moderate injury.



NOTICE

NOTICE directs your attention to the risk of damage to machinery.

1.4 General safety concerns when using the coffee machine

Improper use of coffee machine can lead to potential danger during operation. To avoid personal injury and health hazard, please note following tips when using the coffee machine.



WARNING

Health hazard due to electrical shock

1. Damaged power cords, lines or plug connections can lead to electrocution.
2. Do not connect any damaged power cords, lines or plug connections to the power supply.
3. Ensure that the machine and the power cord are not near any hot surfaces such as gas or electric stoves or ovens.
4. Ensure that the power cord is not pinched and does not chafe on sharp edges.
5. Immerse power plug in water or other liquids are not allowed, as well as pouring water or other liquids on the power plug. Power plug must be dry.
6. Repairs or servicing improperly performed on electrical systems can lead to electrocution.
7. Have servicing work carried out by authorized persons with corresponding qualifications only.

**WARNING****Danger of suffocation**

1. Plastic packaging materials could cause children to suffocate.
2. Ensure that children and persons with reduced physical, sensory, or mental capabilities have no access to plastic packaging materials.

**CAUTION****Risk of scalding**

1. Hot liquids during cleaning can lead to scalding. Keep hands away from the spouts during this process.
2. Do not put anything on the drip grid.
3. Use only suitable drinking vessels.
4. Always be careful with hot drinks.
5. IN CASE OF SCALDING: Immediately cool the affected area and consult a doctor, depending on the severity of the injury.

**CAUTION****Risk of injury**

1. If objects drop into the grinder, splinters may be ejected, leading to injury.
2. Never put any objects into the grinder.

**CAUTION****Cutting injuries/crushing**

1. Active components in the interior of coffee machine will hurt fingers or hands.
2. Remember to switch off coffee machine and unplug the power supply before remove grinder or reach into brew module.

**CAUTION****Irritation from cleaning agent**

1. Cleaning tablets, milk system cleaning agent, and descaling agent can lead to irritations.
2. Observe the hazard warnings on the label of the respective cleaner.
3. Avoid contact with your eyes and skin.
4. Wash your hands after contact with cleaning agent. Consult a doctor if necessary.
5. Cleaning agent must not find their way into drinks.

**CAUTION****Health hazard due to germ formation**

1. Inadequate cleaning can result in food residues accumulating in the machine and at the nozzle, thereby contaminating products.
2. Do not use the machine unless it has been cleaned according to the instructions.
3. Clean the machine daily in accordance with the instructions.
4. Inform operating personnel of the necessary cleaning measures.
5. If the machine is not used for extended periods, residue may accumulate. cleaning the machine before using.
6. Using a water filter for too long can lead to the build-up of algae. Replace the water filter when prompted to do so by the machine.
7. Coffee beans, and fresh milk must in the expiration date.

2. Description of machine

2.1 Machine overview

The E60 series coffee machines are available with numerous options. A sample configuration is illustrated here. Please note that your coffee machine may look different from the configuration shown here.



Open the operation panel

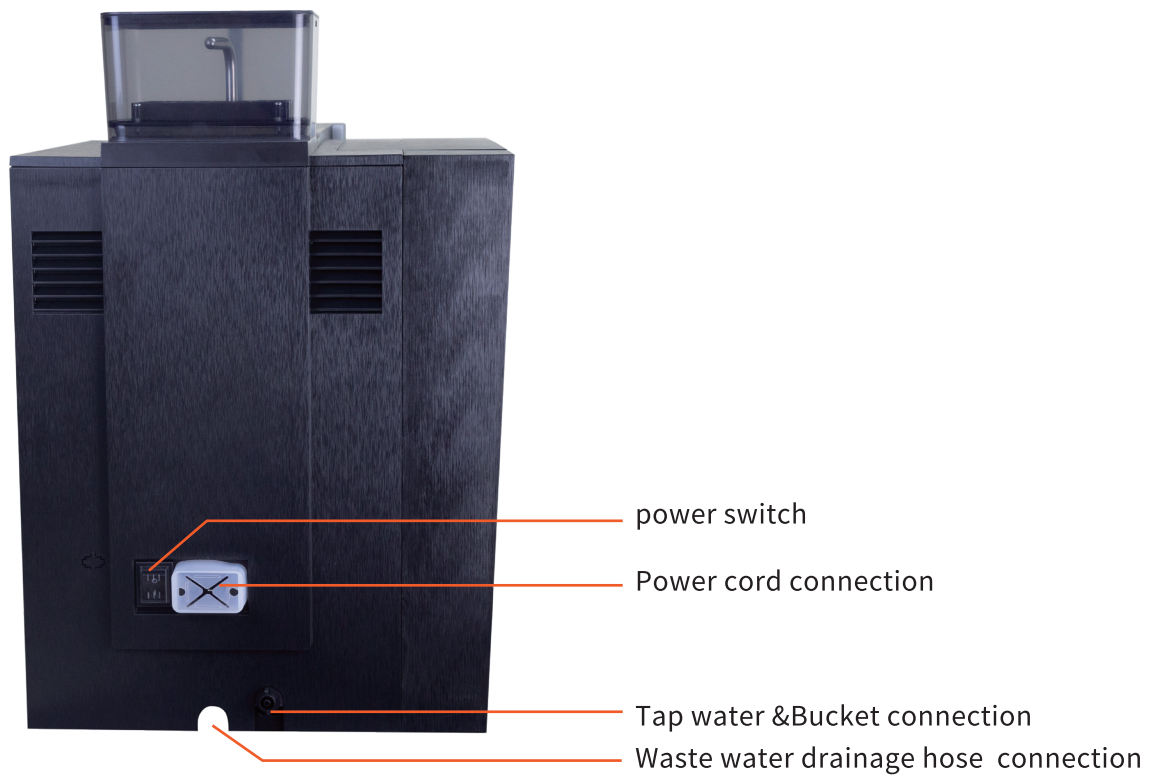

2.2 Screen interface

E60 series are available with two kinds of user interfaces-standard and self-service-to satisfy the needs of different scenarios. See page 23 for changing the themes.

2.2.1 Standard interface



Touching 'logo' icon can access to the menu and change the interface in machine setting menu



2.2.2 Self-service interface



Touching 'logo' icon can access to the menu change the interface in machine setting menu

2.3 Scope of delivery

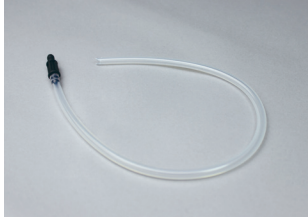
The scope of delivery may vary, depending on the device configuration

Part	Picture	Quantity
Key		1
Milk pipe		1
User manual		1
Barreled water pipe		1

2.4 Technical data

Screen dimensions	10.1 Inches
Water tank capacity	6 L (E60L) 2 L (E60)
Drip tray capacity	2 liters
Grounds container capacity	50 pieces
Coffee spout height	75mm-155mm
Permissible Water pressure	0.5~6 bar
Bean hopper capacity	1000g
Power supply type	220-240V 50Hz
Power rating	3100W
Machine Dimensions	304*572*559(E60) 391*572*559(E60L)
Net weight	18kg(E60) 20kg(E60L)

3. Installation

3.1 Installation tips

1. Only an instructed service-engineer may install the machine.
2. The manufacturer is not liable for injuries caused by an improper mounting of the unit.
3. Installation must use original accessory.
4. Installation personnel will carry out the initial commissioning process for your coffee machine and walk you through the basic functions.



Please contact customer service for further support if you have any questions

3.2 Dimensions

Dimension unit: millimeter

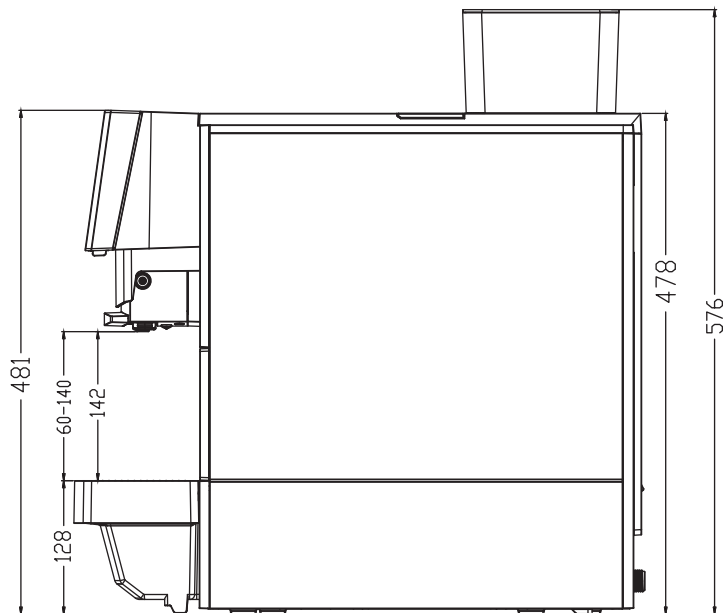
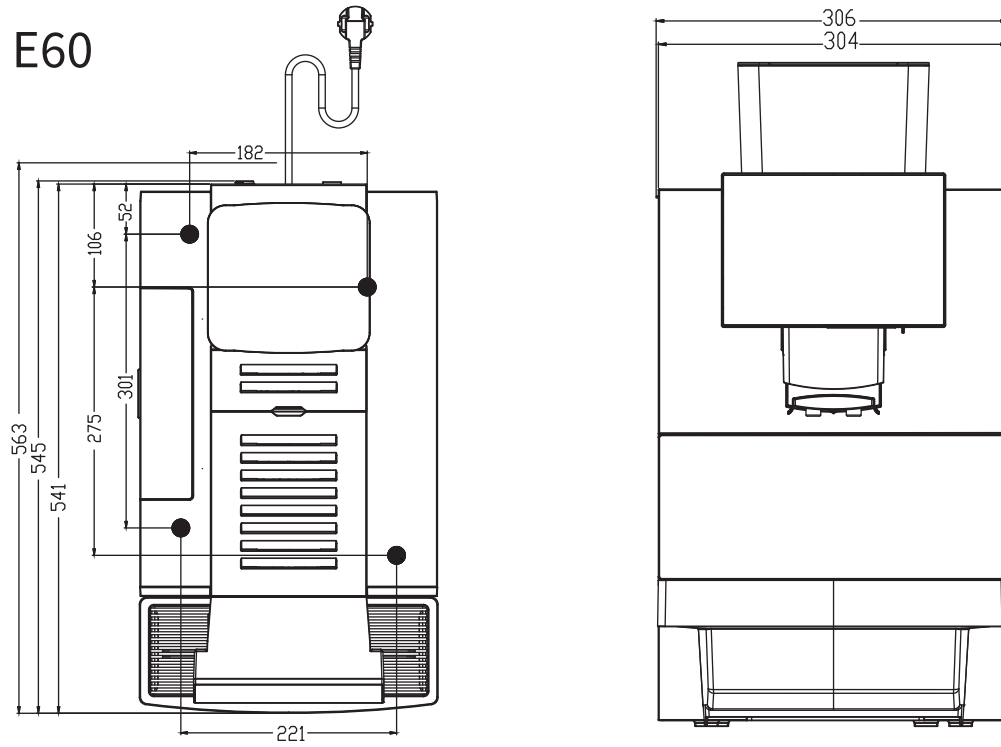

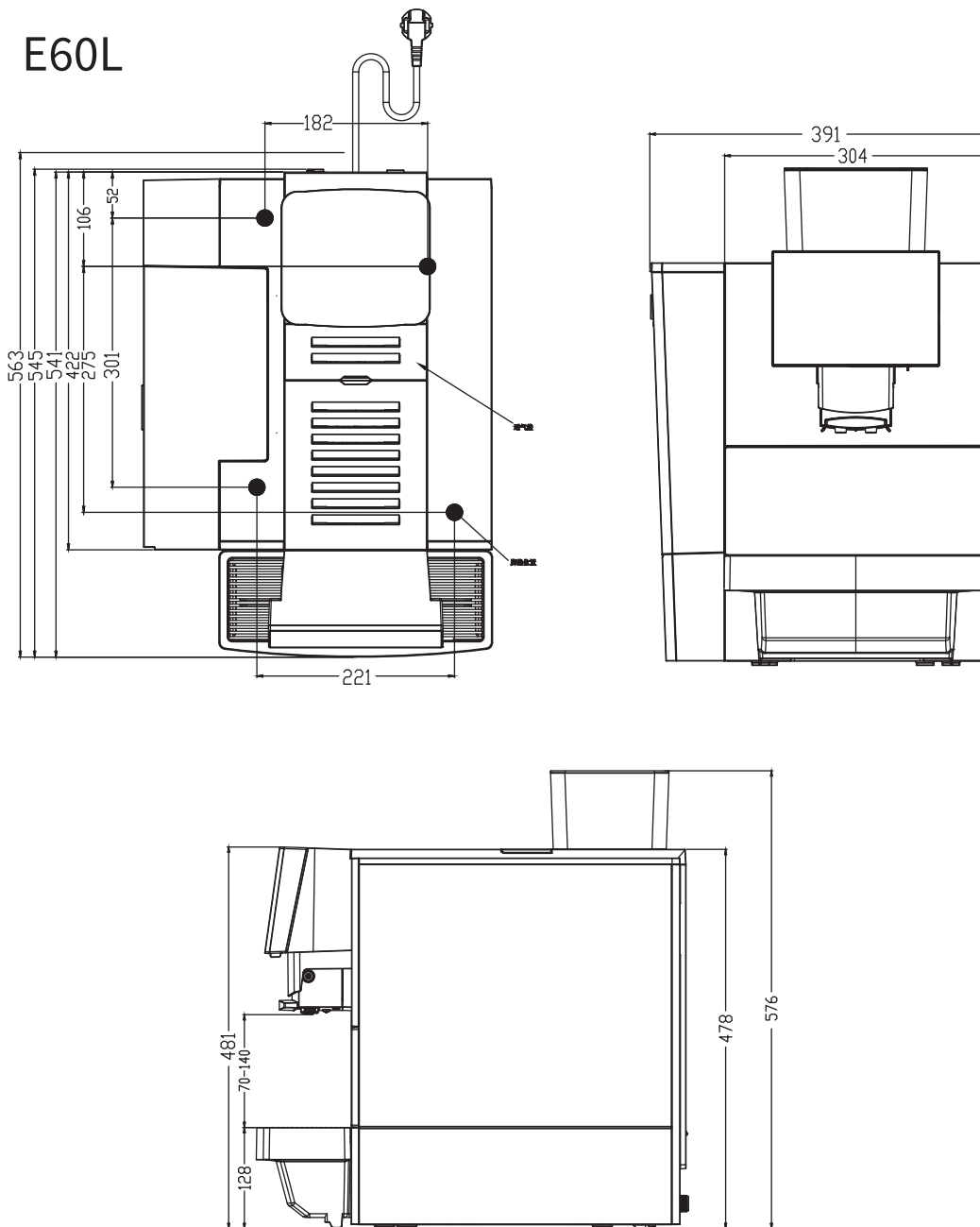

3.3 Installation location

1. The installation location must be dry and protected against water spray
2. Some condensate, water, or steam can always be discharged from a coffee machine
3. Do not use the coffee machine outdoors.
4. The machine has to be installed on a solid, level and heat-resistant base.
5. The surrounding temperature must be between 5°C~35°C.

3.4 Electrical connection

1. The mains connection must correspond with the voltage, amperage and frequency indicated on the machine label.
Installation of wrong or improper electric plugs can cause short circuit resulting in fire. The plug has to be selected and installed by qualified service personnel only.
2. The M50 series are electrically safe only when properly earthed as described in the current electrical safety specifications. Check for compliance and, when in doubt, have the wiring thoroughly inspected by skilled personnel.
3. The manufacturer does not take any responsibility for any damage caused by incorrect earthing or improper use of power supply .
4. No action needed from users to shift the product between 50 and 60Hz, product can adapt itself for both 50 and 60 Hz.

3.5 Water supply connection

Tank water supply and barreled water supply are available for the E60 series. Tank water supply and barreled water supply are the standard configurations when the factory setting has been finished. Default water supply is water tank.

3.5.1 Water quality

Total hardness:	4 – 8 dH GH
	70 – 140 ppm (mg/l)
Carbonate hardness	3–6 dH KH / 50–105 ppm (mg/l)
Acid content/pH value	6.5–7.5 pH
Chlorine content	< 25 mg/l
TDS	30 – 150 ppm (mg/l)
electric conductivity	50–200 μ S/cm (microsiemens)
Iron content	< 0.3 mg/l

To guarantee the required water quality, a water filter system needs to be installed

3.5.2 Barreled water connection

E60 and E60L are available with barreled water supply.

3.5.3 Automatic waste water drainage connection

The distance between the water drain and the machine should not be more than 1 meter. For proper draining, make sure that the water drain (hose) does not sag.

4. Start-up for the first time

4.1 Material filling

Adding material into the machine. See page 14 for specific operation



Please use water tank supply for first time use

4.2 Initially start-up program setting

After switch on the machine initially, access to the setting of start-up program for the first time is available. Specific process as follows:



1. Plug the mains cable for the coffee machine into an electrical outlet and press the power switch



2. Press the screen power button

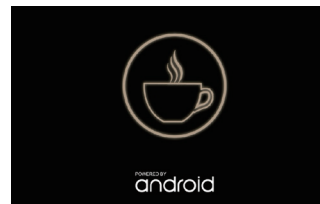

3. Screen is on

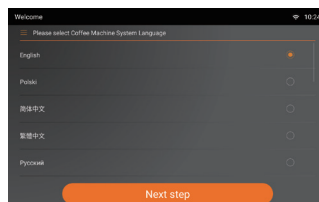

4. Select language

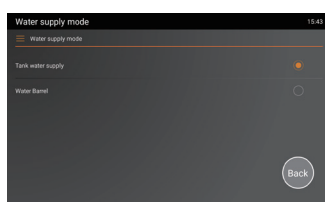

5. Set water supply mode

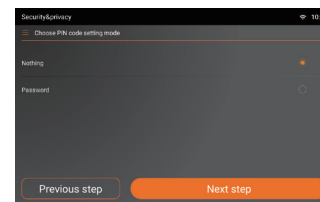

6. Set PIN code

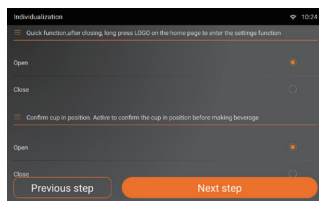

7. Set individualization

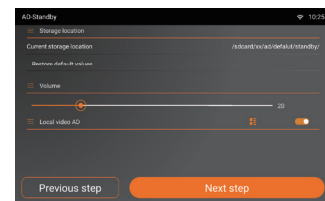

8. Set AD

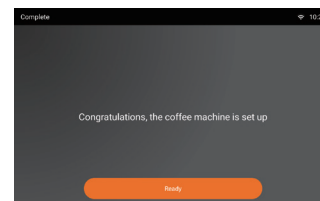

9. Click 'Ready' to finish the setting

5. Operation

5.1 Coffee beans filling



1. Lift bean hopper lid



2. Add coffee beans



3. Attach lid and lock it (if need)



Never put any objects into the bean hopper or grinder. Otherwise, splinters may be ejected, leading to injury.



1. Do not pour ground coffee into bean hopper
2. Do not pour any liquids into bean hopper

5.2 Water tank filling



1.Pull out the water tank



2.Fill water tank with drinking water



3.Attach water tank (Ensure water tank is installed in position)



- 1.Surface of water can not over the maximum marking identification of water tank
- 2.Do not fill the water tank with hot water, which may damage machine.

5.3 Milk connection



1.Connect milk pipe to machine



2. Insert the milk pipe into the milk container



Store milk in a cooler

5.4 Switch on machine



Process of switch on the machine please see page 13 start-up for the first time/start-up program.

5.5 Beverage preparation

5.5.1 Beverage preparation in standard interface

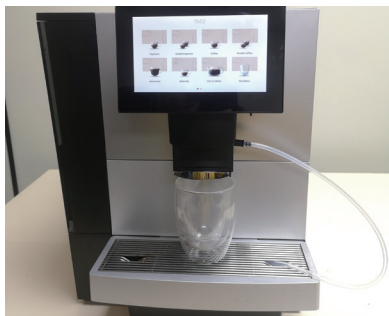

1. Place an appropriate cup under the beverage outlet



2. Touch beverage icon

3. Beverage in preparing

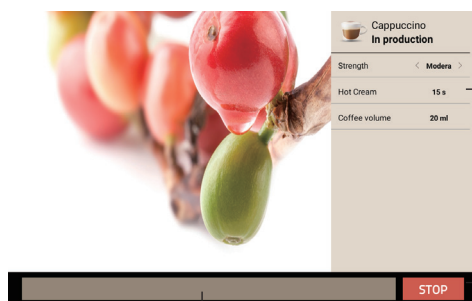

Process bar

Touch '<' '>' can change parameter during the beverage preparation

Cancel beverage preparation by touching 'Stop'

5.6 Grinding coarseness setting

Grinding coarseness could be calibrated by using calibration program. Contact your customer service for the help.

6. Program setting

6.1 Access to the menu



1. Touch logo icon on the upper-left corner

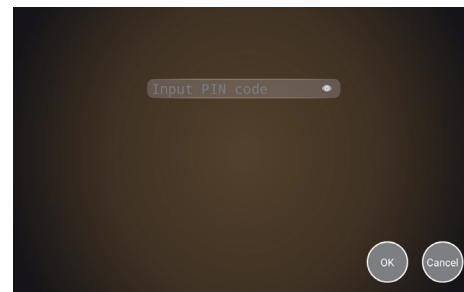

2. Input PIN code and touch OK

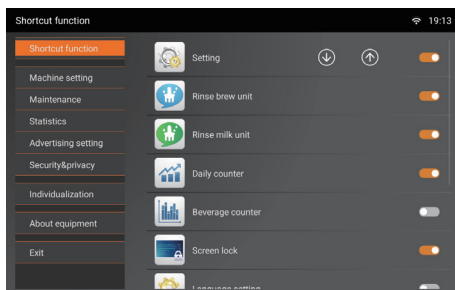

3. Select the target menu



1. PIN codes can be set in the start-up program for the first time. If PIN codes are not be set, the default codes are empty

6.2 Program setting menu tree

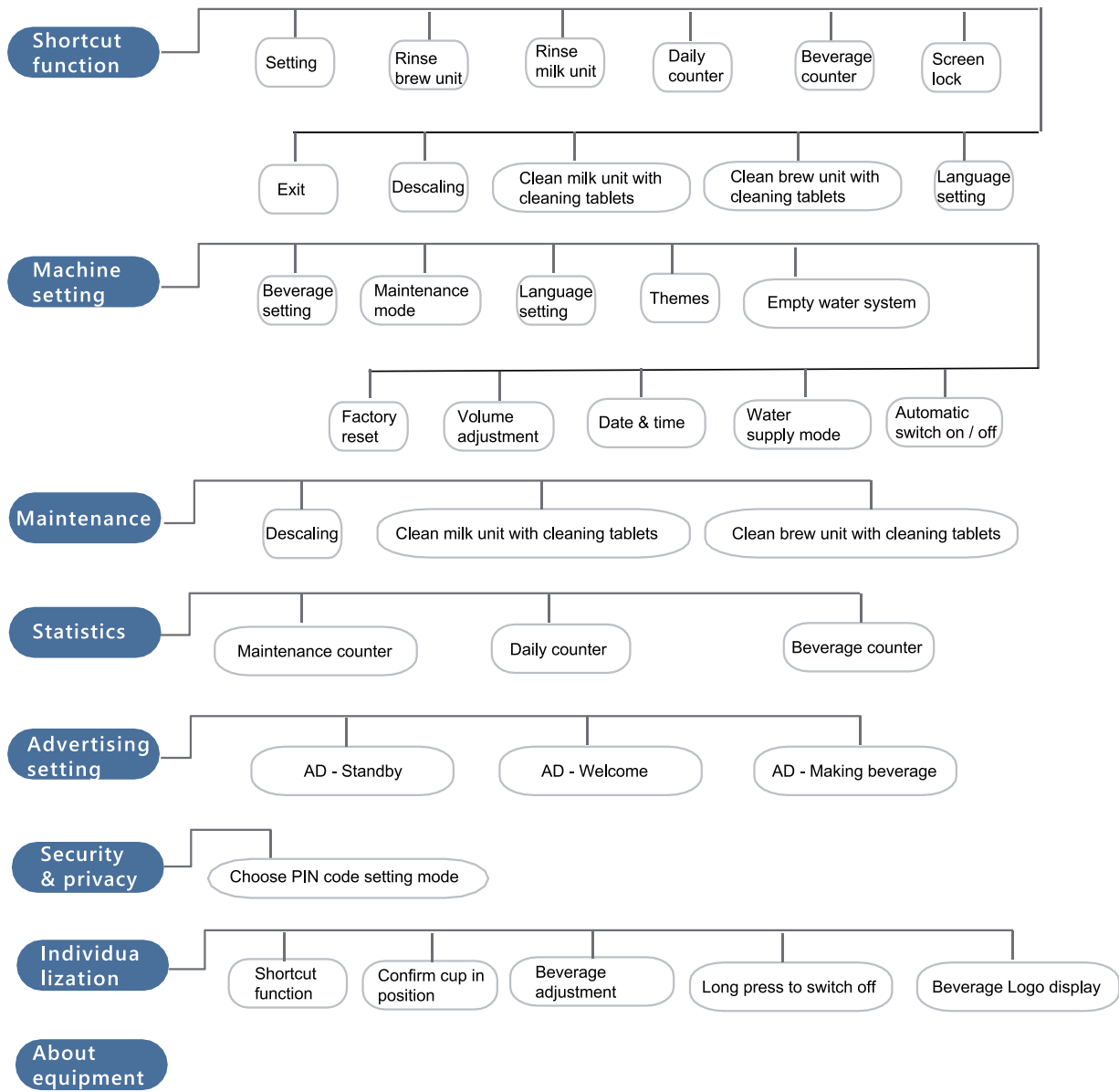

6.3 Shortcut function

6.3.1 Overview of shortcut function

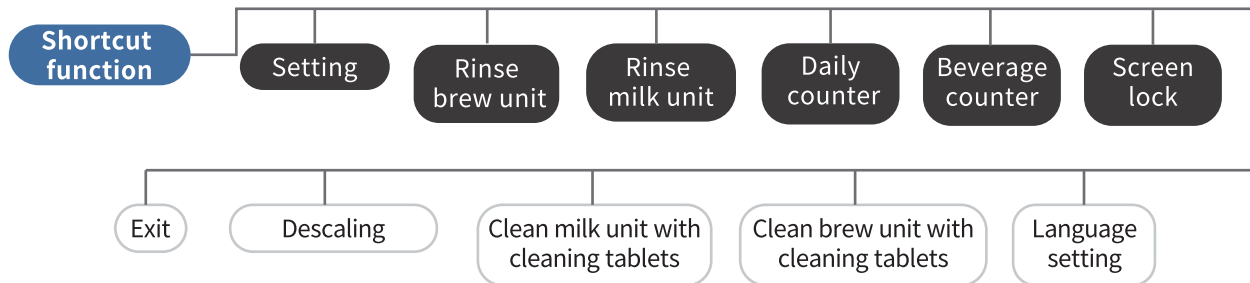

6.3.2 How to use the shortcut function

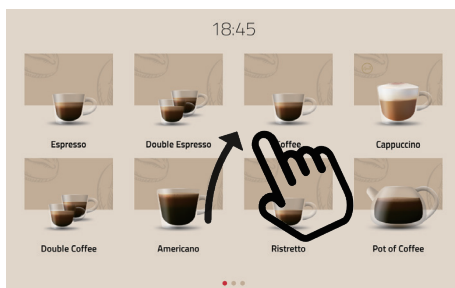

1. Slide up from bottom of the page

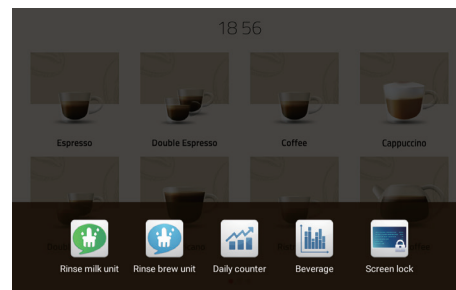

2. Shortcut menu will be displayed

6.3.3 Take rinse brew unit as example

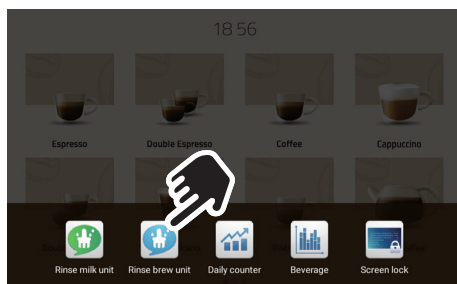

Tap rinse brew unit icon

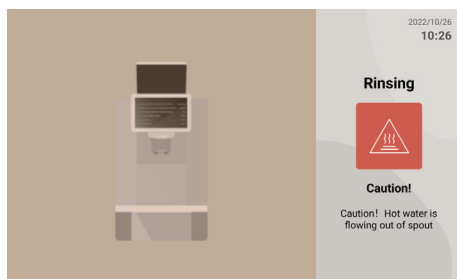

Brew unit is rinsing

6.4 Machine setting

6.4.1 Beverage setting overview

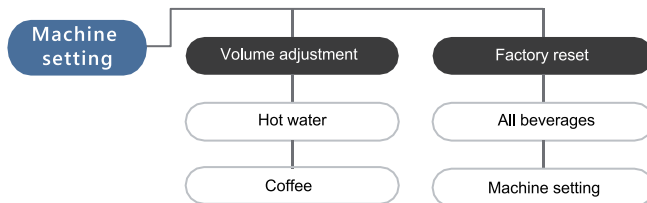
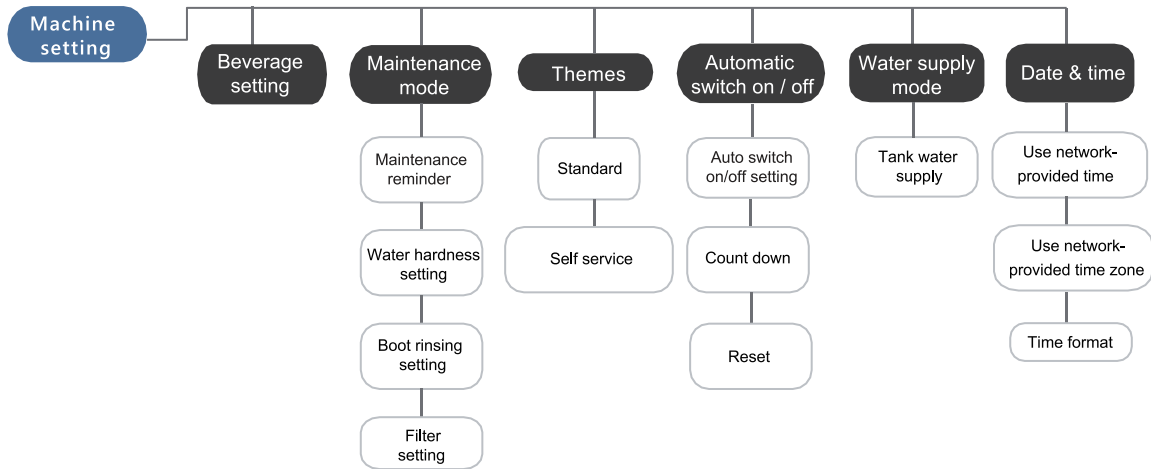

6.4.2 Beverage setting

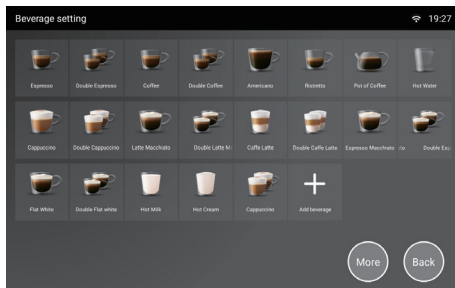

1. Add new beverage

Tap '+' that you can select new drink you want to add from popup list. The beverage icons and name can only be selected from the existing ones here.

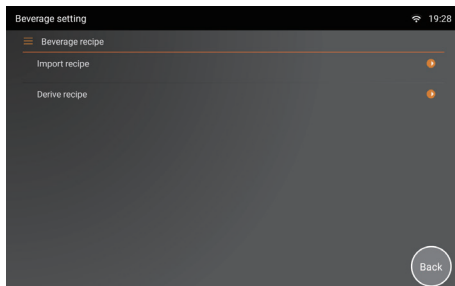

2. Copy the beverage recipe

Insert USB stick and tap 'More'

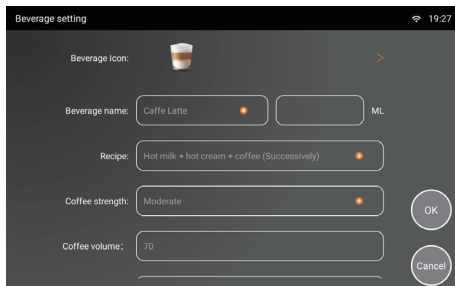

3. Recipe setting

Take caffe latte as example

Tap recipe, change recipe parameter is permitted.

Specific settable value range needs to comply with limited condition of software.

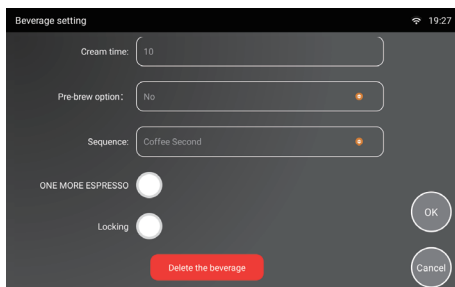

4. One more espresso

Grinding twice if activate this function when making coffee

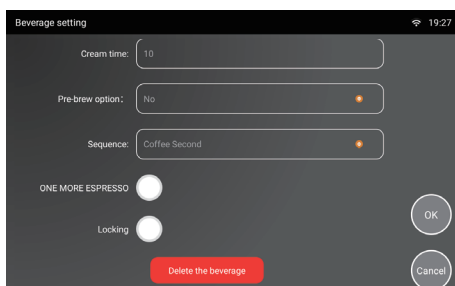

5. Lock the beverage

Tap 'Locking', the beverage will be locked and cannot be prepared

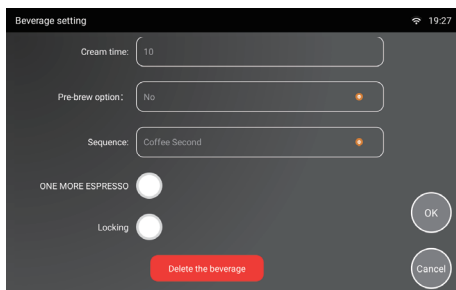

6. Delete the beverage

Tap ‘Delete the beverage’ icon, the beverage will be deleted from beverage list.

6.4.3 Maintenance mode

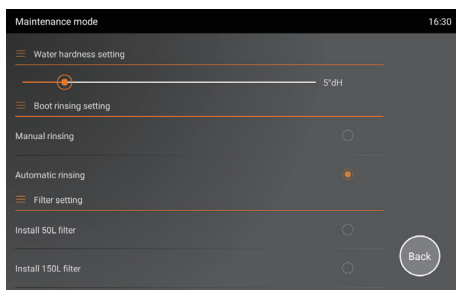

1. water hardness setting

Test local water hardness using water test strip before setting up the machine, then setting correct water hardness value.

2. Manual rinsing

Click ‘OK’ to perform boot rinsing after switched on the machine.

Automatic rinsing

Perform boot rinsing automatically after switched on the machine.

3. Select ‘No filter’ if not install the filter

Select 50L/150L here if install or replace filter

Default setting: No filter

6.4.4 language setting

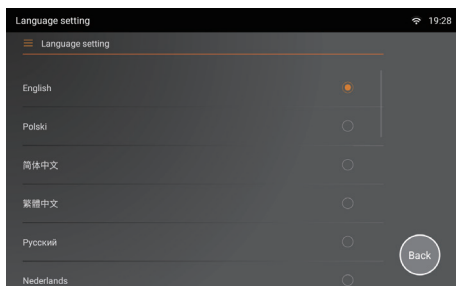

Display available language here.

Select language.

Default language setting is English.

6.4.5 Themes

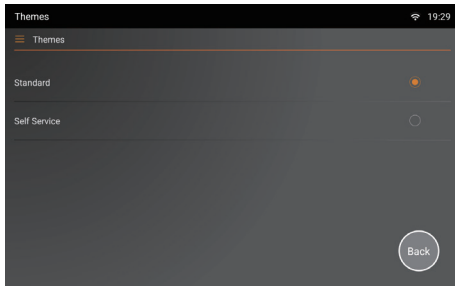

Standard and self-service interface can be selected here.

6.4.6 Empty water system

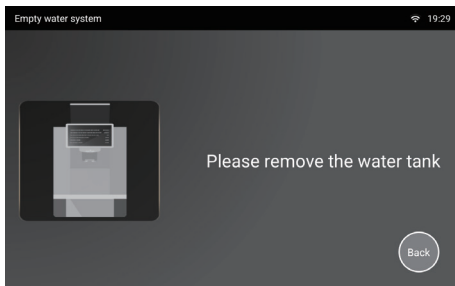

Empty water system needs to be performed if the machine has been left for a long time or before transport.

6.4.7 Automatic switch on / off

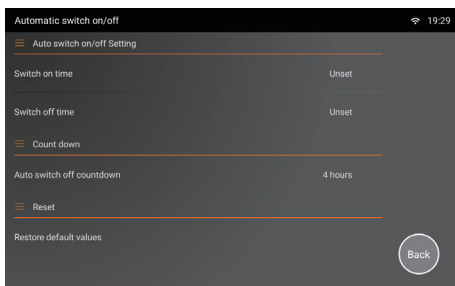

Auto switch on/off and auto switch off count down can be set here.

6.4.8 Water supply mode

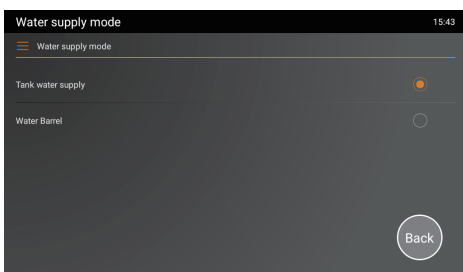

Water supply mode

Tank water supply and barreled water supply are available .

Select corresponding water supply mode. Default setting is tank water supply.

6.4.9 Date & time

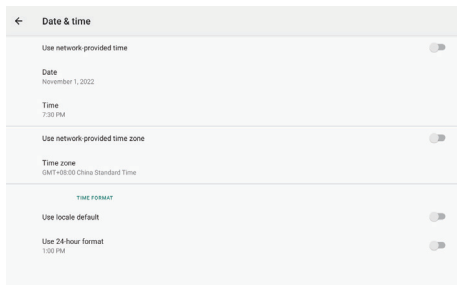

Date

Set local date

Time zone

Set local time zone

Time

Set local time

6.4.10 Volume adjustment

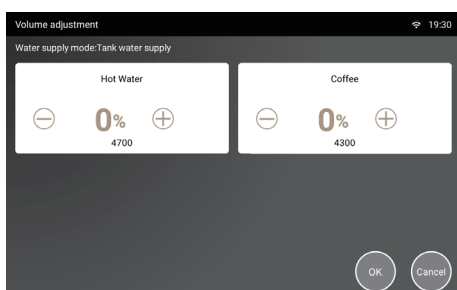

Contact customer service if use this function

6.4.11 Factory reset

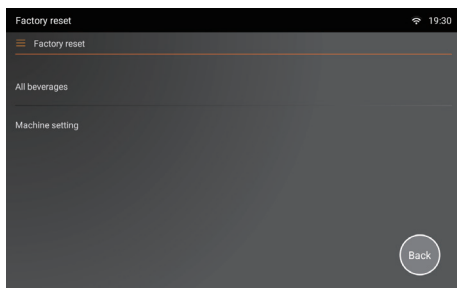

1. All beverage reset

Restore all relative parameter of beverage to factory default setting.

2. Machine setting reset

Restore all parameter of machine to factory default setting.

6.5 Maintenance

6.5.1 Clean brew unit with cleaning tablets

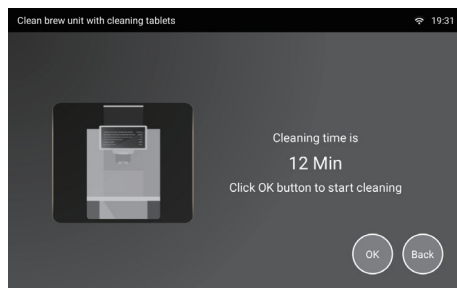

1. Clean brew unit with cleaning tablets
The cleaning frequency is every 300 cups of coffee.

2. Operate according to the instructions on the display, cleaning time is about 12 Min.

6.5.2 Clean milk unit with cleaning agent

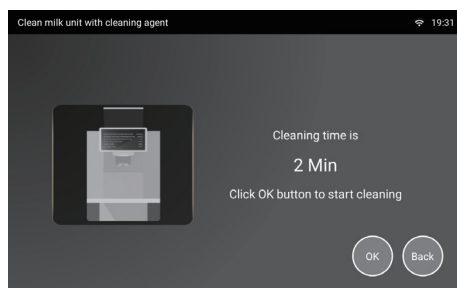

1. Suggest clean milk unit with cleaning agent every week

2. Operate according to the instructions on the display, cleaning time is about 2 Min.

6.5.3 Descaling

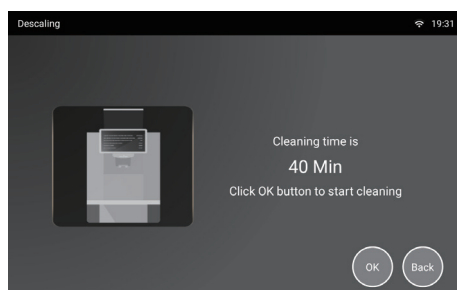

1. The descaling frequency according to water hardness.

Operate according to the instructions on the display, cleaning time is about 40 Min.

6.6 Statistics

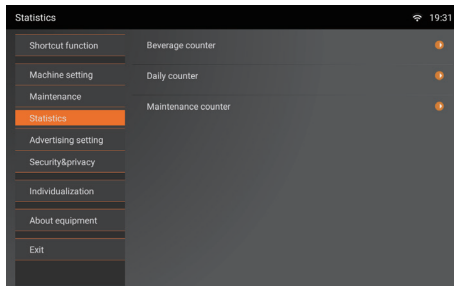

View the history records of various beverage preparation data, total drink numbers, care and maintenance here.

6.7 Advertising setting

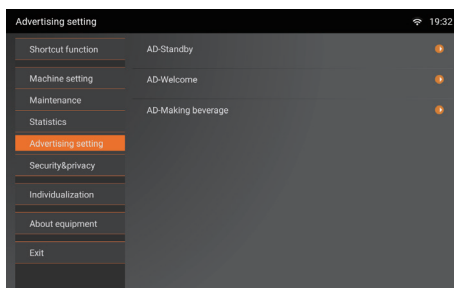

Three different kinds of AD can be set: Standby ,Welcome and Making beverage.

AD – Standby

Set advertisement videos when the machine is in standby. Advertising resources could be loaded from USB stick.



Advertising setting is available here, videos and images used can be loaded from USB stick



Video requirements: MP4 format,preferably less than 100M,720P, recommended resolution ratio:1080*720,30FPS,30 frames per second, image format:png/jpj/peg/bmp/,display resolution size:1024*600

AD - Welcome

Set advertisement videos when the machine is started.



Video requirements: MP4 format,preferably less than 100M,720P, recommended resolution ratio:1080*720,30FPS,30 frames per second, image format:png/jpj/peg/bmp/,display resolution size:1024*600

AD – When making beverage

Set advertisement videos when the beverage is in production.



Video requirements: MP4 format,preferably less than 100M,720P, recommended resolution ratio:1080*720,30FPS,30 frames per second, image format:png/jpj/peg/bmp/,display resolution size:1024*600

6.8 Security & privacy

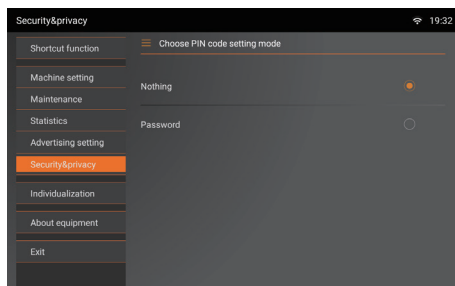

PIN code setting

PIN codes can be set in the start-up program for the first time use or set here . If PIN codes are not be set, the default codes are empty



If you forget the PIN codes, please use the master PIN code 800866

6.9 Individualization

6.9.1 Shortcut function

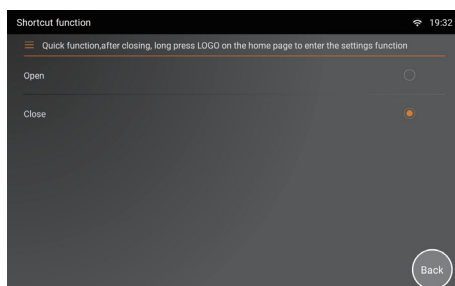

Select ‘Open’ , shortcut function will be activated.

6.9.2 Confirm cup in position

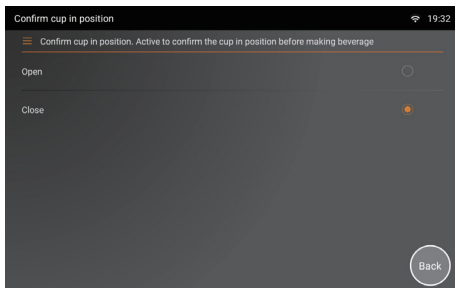

Select **‘Open’** , there are 12s to adjust cup position when beverage in preparation.
 Select **‘Confirm’** to continue if the cup in position already.

6.9.3 Beverage adjustment

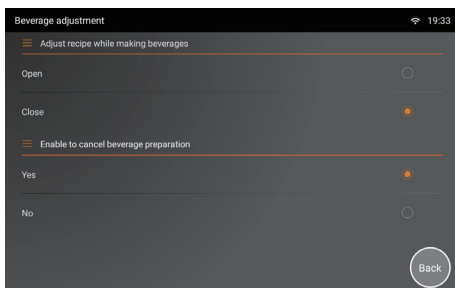

1.adjust recipe while making beverage

Select **‘Open’** , beverage recipe can be changed when making beverage.
 Select **‘Close’** , beverage recipe can not be changed when making beverage .

2. Enable to cancel beverage preparation

Select **‘Yes’** , beverage preparation can be canceled when beverage in preparation.
 Select **‘No’** , beverage preparation can not be canceled when beverage in preparation.

6.9.4 Long press to switch off

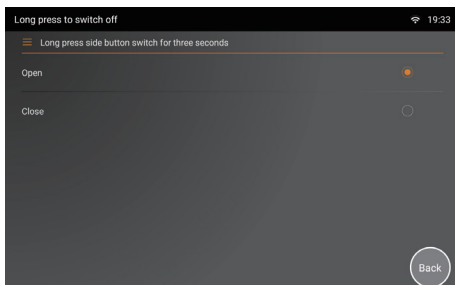

Switch off button

1. Select **‘Close’** , press power button lasts 3 seconds to turn off the screen.
2. Select **‘Open’** , the function of screen power switch is disabled.



Screen power switch

6.9.5 Beverage logo display

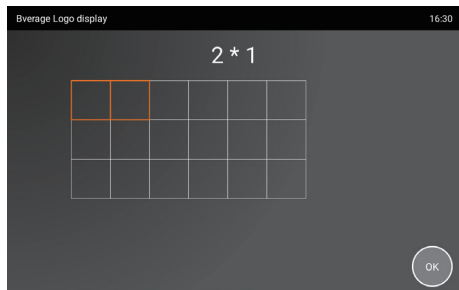

Change beverage layout as you want casually

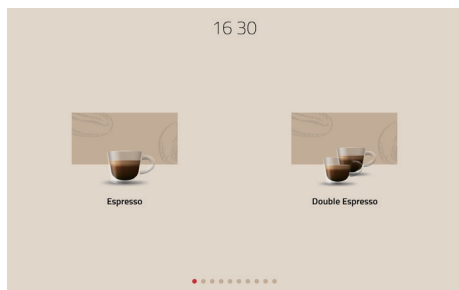

6.10 About equipment

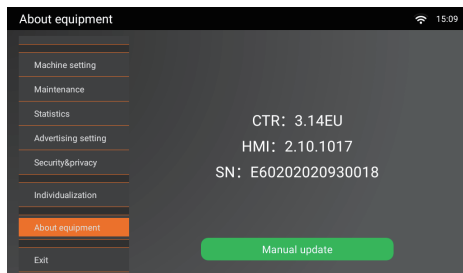

Information regarding this machine could be viewed here including, Ctr version (PCB software) HMI version (Screen software) and serial number of machine.

Upgrade software via USB stick

Program of machine can be upgraded by USB stick



Software program upgrade needs to be instructed by professional technician, contact customer service personnel for help

7. Cleaning and maintenance

The perfect coffee experience depends on a perfectly cleaned coffee machine. Clean your coffee machine at least once a day and more frequently if necessary. Clean the machine immediately if you find that it is dirty or clogged.

7.1 Cleaning intervals overview

Cleaning intervals	Operation	Type
Daily (or needed)	Brew unit rinsing	automatic or manual
	Milk frother rinsing	automatic or manual
	Empty drip tray	manual
	Empty grounds container	manual
	Clean the screen	manual
	Clean milk frother	manual
Weekly	Clean the brew unit	manual
	Milk frother rinsing	manual
	Clean the bean hopper	manual
	Milk system cleaning	manual
	Clean the water tank	manual
If presents	Clean the brew unit	When the screen shows a message
	Descaling	When the screen shows a message
	Filter change	When the screen shows a message

7.2 Parts preparation

Parts	Usage
Cleaning tablet	Brew unit cleaning with tablet
Milk system cleaning agents	Milk system cleaning
Brush	Clean the brew unit manual
Descaling powder	Descaling
key	Adjust milk frother
Milk hose brush	Clean milk hose manually
Damp cloth	Clean the hoppers, screen, machine surface

7.3 Daily cleaning

7.3.1 Brew unit rinsing

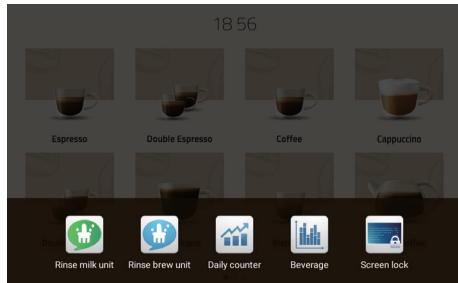

1. Immediately rinse can be selected manually in short-cut menu and touching rinsing option can rinse at once.



2. Brew unit is rinsing.



Hot water will be dispensed from coffee spout during rinsing, be careful to avoid scalding

7.3.2 Milk frother rinsing automatically

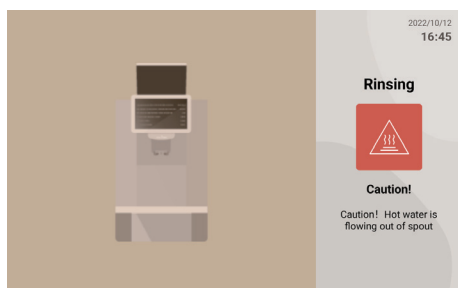

Milk frother will be rinsed automatically in 5 min after the preparation of milk-based beverage.

7.3.3 Empty grounds container

Empty grounds container (at least once per day).



1. Remove grounds container



2. Pour out the coffee grounds



3. Clean it thoroughly with fresh water



4. Dry and place the grounds container back

7.3.4 Empty drip tray

The drip tray is below the grounds container. Clean the drip tray as needed (at least once per day).



1. Remove the drip tray



2. Pour out waste water



3. Clean it thoroughly with fresh water



4. Dry and place the drip tray back



Must clean the two metal plates in front of the drip tray and keep them dry, otherwise, 'empty drip tray' will be misreported

7.3.5 Clean the screen

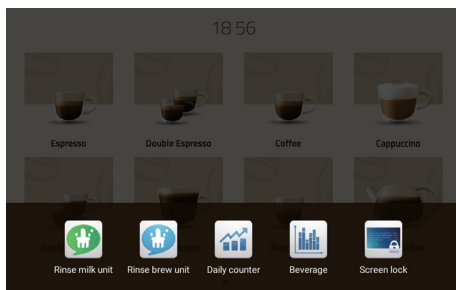

Enter **‘Slide up the screen’** start a 12- second to countdown.
Now screen can be wiped by a dry cloth.

7.4 Weekly cleaning

7.4.1 Cleaning milk frother manually



1. Take the milk frother out



2. Disassemble the milk frother



3. Clean milk frother with fresh water and assemble it back



4. Place it back



Specific process of cleaning milk frother manually can be viewed from [‘Help/video/cleaning milk frother’](#) manually

7.4.2 Clean the bean hopper



Bean hoppers can be cleaned when needed and at regular intervals (recommendation: weekly).

1. Switch off coffee machine firstly and disconnect mains plug.
2. Remove the bean hopper lid.
3. Using the key to unlock the lid.
4. Remove the bean hopper, empty it out, and clean it with a damp cloth.
5. Dry the bean hopper completely and place it back and lock it.

7.4.3 Clean the brew unit with the brush

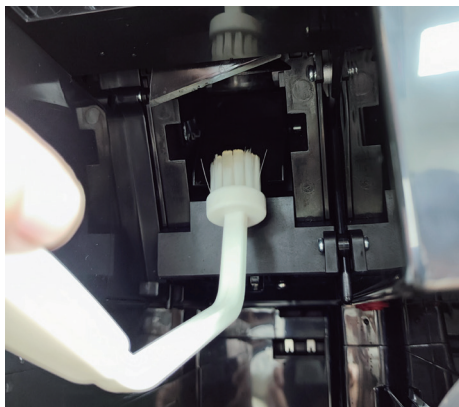

Brew unit will be clogged when coffee beans are grinded too fine. Suggest using brush clean brew unit per week.

7.4.4 Milk system cleaning

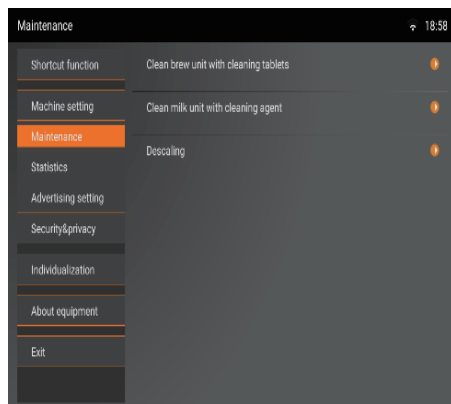

1. Access to **'Maintenance'** menu and Select clean the milk unit with cleaning agent.

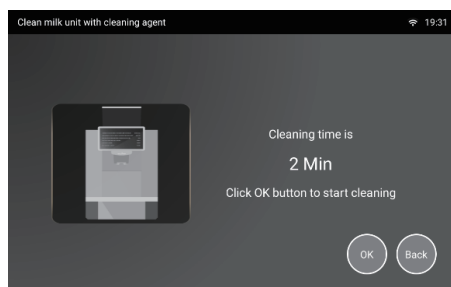

2. Touch **'OK'** button

3. Perform every step according to the message displayed on the screen



If milk system cleaning with cleaning agent is not be carried out in time, The milk scum can block the outlet and make it impossible to make milk foam.



During cleaning, hot cleaning solution will flow out of the spout. So never reach under the spout while cleaning.

7.5 Clean the brew unit if presents

A message 'Clean brew unit' will appear on the screen when the brew unit need to be cleaned with a tablet. Total duration is approx. 12 minutes.

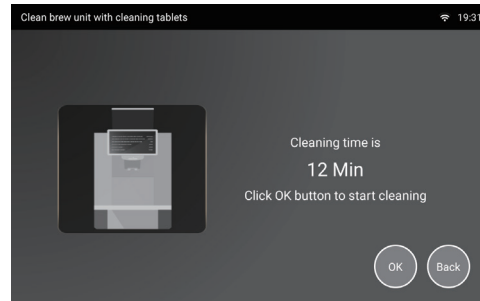
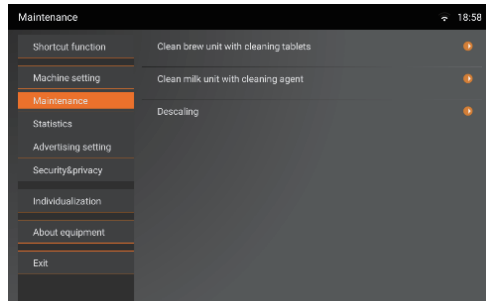

1. Access to 'Maintenance' menu and select clean brew unit with cleaning tablet

2. Touch 'OK' button

3. Perform every step according to the message displayed on the screen.



During cleaning, hot cleaning solution will flow out of the spout. So never reach under the spout while cleaning.

7.6 Descaling if presents

A message 'Descale the machine' will appear on the screen when the machine need to be descaled with powder. Total duration is approx. 40minutes.

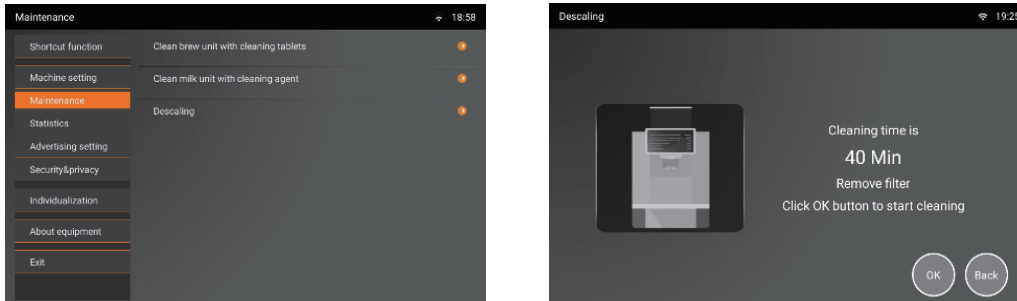

1. Access to 'Maintenance/Descaling' menu
2. Touch 'OK' button
3. Perform every step according to the message displayed on the screen.



During descaling, descaling solution will flow out of the spout. So never reach under the spout while descaling.

8. Messages and explanation

8.1 Operational messages

Information	Possible solutions
Drip tray is full	Need to empty drip tray
Install drip tray	Need to install drip tray or it is not in the correct position
Empty grounds container	Need to empty coffee grounds after every 50 cups of coffee
Fill water tank	Fill water to the water tank or place water tank back
Fill beans	Fill beans to the bean hopper
Bean hopper not in position	Place the bean hopper back
Low temperature	Restart the machine
High Temperature	Restart the machine
Milk temperature too high	Use milk below 25°C
Milk temperature too low	Use milk above 4°C

8.2 Error message

The error message will appear automatically when the entire system is affected by an error. Restart machine if serious problems appeared.

1. Switch off the machine by main switch when restart the machine
2. Please contact service technician if the machine cannot be started or if you are unable to fix error

Error code	Error description	Possible solutions
Error1	No heating from thermoblock	Check the thermoblock
Error2	NTC of thermoblock is malfunctioned	Check the NTC
High Pressure	Water flow meter detects very little water	Check the water circuit
System empty	Water flow meter detect no water	Check the water circuit
Error6	After pressing 'OK' for more than three times when 'High Pressure' or 'System empty' displayed	Check the water circuit
Brew unit reset error	The brew unit gear does not run for correct cycles	Check the brew unit
Grinder error	The coffee beans is less than 6.5 gram	Check the grinder unit
Serial port failure, please check the serial port connection	No communication between CTR and HMI	Check the main PCB

9. Decommissioning

9.1 Preparing for decommissioning

1. Clean the machine by using all cleaning and rinsing function.
2. Cleaning after empty bean hopper.
3. Clean beverage spout and milk pipe manually.
4. Clean brew unit manually.
5. Clean mixer manually.
6. Clean drip tray and grounds container etc.

9.2 Short-term decommissioning (within one month)

1. Empty Coffee circuit (Have your coffee machine drained by your service technician).
2. Disconnect the machine from the power supply.
3. Shutting off the water supply.
4. Switch off the add-on units and disconnect them from the power supply.

9.3 Long-term decommissioning (over one month)

Some components may no longer function as they should if they have been stored or unused for long periods.

Coffee machine must be maintained, installed, and cleaned before preparing any drinks.

1. Have your coffee machine drained by your service technician.
2. Remedial maintenance may be required when commissioning the machine again if it has been stored in excess of 6 month. Please contact service personnel for support.

10. Transport and storage

10.1 Transport

Protect the machine from mechanical damage and adverse environmental conditions during transport and storage.

1. Protect the machine from falling or tipping over.
2. Restore external packaging of machine well to use in transportation.
3. In order to avoid the damage to machine, water in the coffee machine must be emptied before transportation.
4. After the completion of emptying water circuit, dry the machine, inside and out.



Empty water circuit must be performed by professional technician, please contact service personnel for support



If the program of emptying water circuit is performed, coffee system needs to re-perform the program that has been carried out in the first time use when using the machine again

10.2 Storage

Storage conditions must be fulfilled:

1. Permissible temperatures: -10 to +50°C
2. If the machine has not been drained and emptied completely, it must not be stored at sub-zero temperatures
3. Set the machine up in a standing position
4. Machine system emptied
5. Machine and accessories packaged, preferably in their original packaging.

10.3 Recommissioning after prolonged periods of storage or non-use

Coffee machine may no longer function if they have been stored or unused for periods in excess of 6 months. Contact your service team for information regarding restoring and recommissioning your machine.

11. Disposal

When disposal of coffee machine, some internal spare parts are still worth using again, Pay attention to deal with old parts in an environmentally neutral way.

1. Beans can be composted.
2. Observe the information on the label when disposing of any unused cleaning agent.
3. Dispose of the fluids from the cleaning container or the drip tray in the wastewater system.



Dispose of electronic parts separately



Dispose of plastic parts in accordance with their marking

